

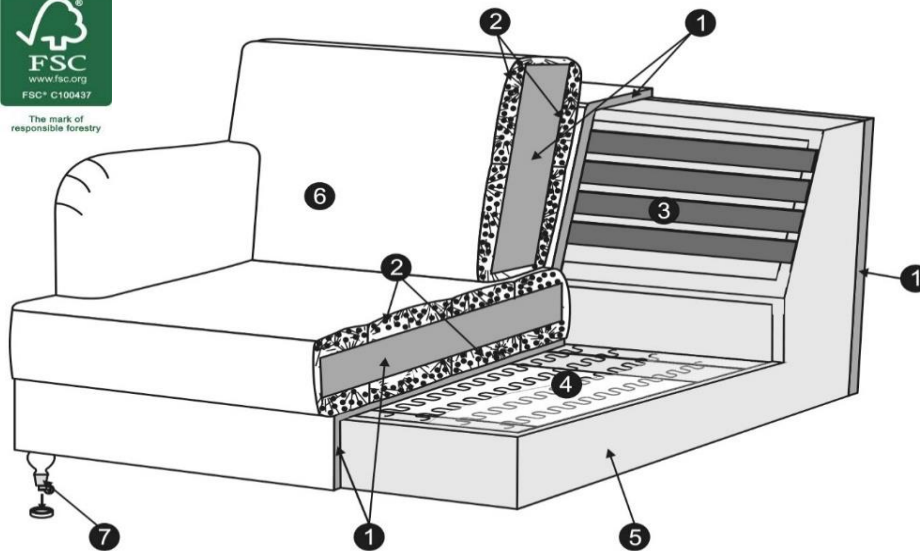

## TECHNICAL SPECIFICATION

### PROFILE

COMFORT: lux



1	polyurethane foam/ high resilient polyurethane foam
2	cushion chamber with mix of feather and silicone balls
3	upholstery belts
4	springs
5	FSC® certified solid wood and wood based elements
6	fabric
7	FSC certified solid wood legs with metal rolls (silver or gold) and floor protection

The producer reserves the right to change construction of products and components used due to improving durability of product and customer satisfaction without any further notice.

### UPHOLSTERY:

fabric and leather: FC - fix cover, Comfort: Lux

### FEET

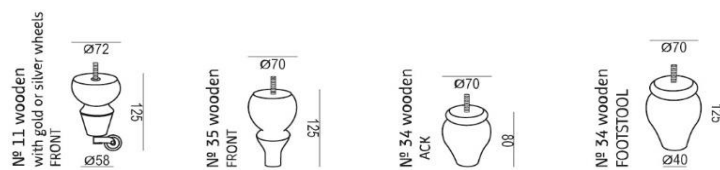

### COLOURS OF WOODEN FEET





## Sales Pricelist 2020

UPHOLSTERY: fabric: FC - fix cover COMFORT: lux

Currency: EUR

Valid till: 31.01.20201

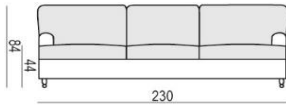
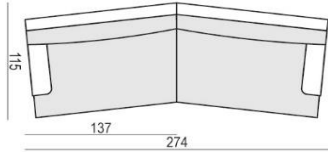
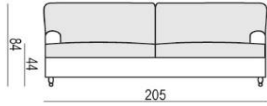
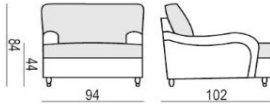
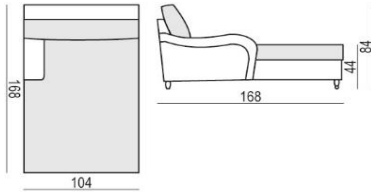
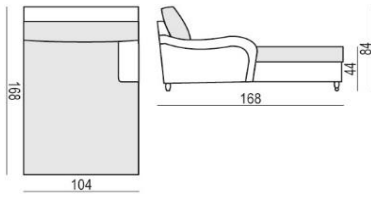
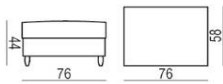
DIMENSION*	DESCRIPTION ARTICLE No	VOL.	WEIGHT	FABRIC USAGE	A	I	II	III	IV	E	
230x102x84/44	<b>3,5 seater</b>										
	FC	E1559-0600-2L	1,70	75	12,8	2 108	2 108	2 304	2 483	2 662	3 327
278/115x102x84/44	<b>3,5 seater (two parts)</b>										
	FC	E1559-0740-2L	2,00	94	14,1	2 644	2 644	2 858	3 073	3 287	4 109
205x102x84/44	<b>3 seater</b>										
	FC	E1559-0400-2L	1,50	67	11,2	1 822	1 822	1 983	2 144	2 304	2 881
94x102x84/44	<b>armchair</b>										
	FC	E1559-0000-2L	0,70	41	6,2	1 043	1 043	1 133	1 222	1 311	1 639
104x168x84/44	<b>chaiselongue left freestanding</b>										
	FC	E1559-1202-2L	1,30	53	8,0	1 518	1 518	1 643	1 769	1 911	2 389
104x168x84/44	<b>chaiselongue right freestanding</b>										
	FC	E1559-1212-2L	1,30	53	8,0	1 518	1 518	1 643	1 769	1 911	2 389
76x58x44	<b>footstool</b>										
	FC	E1559-1045-2L	0,30	11	2,0	486	486	511	536	564	706
extra charge for 4 pcs legs No 11					0						

# HOWARD



home&family



design: SITS

## Sales Pricelist 2020

UPHOLSTERY: fabric: FC - fix cover COMFORT: lux

Currency: EUR

Valid till: 31.01.20201

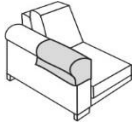
DIMENSION*	DESCRIPTION ARTICLE No	VOL.	WEIGHT	FABRIC USAGE	A	I	II	III	IV	E
<b>armrest protection /set of 2</b>										
	LC E1559-1900-0	0,01	0	1,0	107	107	125	125	143	179

### available sets:

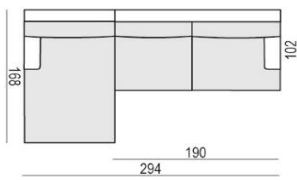
294/168x102x84/44	SET 1 left - 3 seater r. + chaiselongue l.									
	FC E1559-5402-2L	2,60	112	17,8	3 305	3 305	3 573	3 841	4 144	5 180

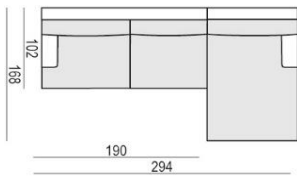
294/168x102x84/44	SET 1 right - 3 seater l. + chaiselongue r.									
	FC E1559-5401-2L	2,60	112	17,8	3 305	3 305	3 573	3 841	4 144	5 180

\*Explicit +/- 2 cm tolerance of all elements sizes

Załączone ceny rekomendowane mają charakter sugerowanych cen sprzedaży. Kupujący nie jest związany cenami rekomendowanymi.