

Range
—
OPTIC



PRICELIST

OVH-HINNASTO (SIS. ALV. 24%) – EURO

FINLAND

01.06.2023



Range

OPTIC

OPTIC is a series of simple and understated designs with an edge. Here we focus on clean lines in an updated format with a timeless quality.

Designed by

Cecilie Kamp

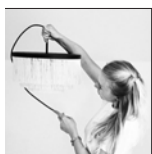

This range include

Dining tables
Coffee tables
HIFI-sideboards
Shelves

Features



Design elements

Choose from different designs and add ons.



Custommade

In addition to our many standard options we can accommodate special requests.



Wood colours

Choose between more than 10+ different wood colours in both ash and oak.



Sustainable choice

Solid wood furniture can last a lifetime with proper maintenance

Social media

Follow and share with us on Instagram.



@kristensenfurniture | #kristensenfurniture

Pricelist- and imagebank

On our Collection-site you as a retailer always have access to the latest pricelists and hundreds of high resolution images and videos - **Free to use in your marketing!**

If you do not have a password yet, please contact the Kristensen sales office in Denmark.

LINK:

<https://collection.kristensen.com/>

PRICELIST

Round dining table (undivided)



PRICE (EUR)

OPTIC round undivided dining table H74 cm w/3 cm wooden plate

D (cm)	Description	Item no.	ASH	OAK
140	Undivided plate	OP3H-140	2.293	2.866
130	Undivided plate	OP3H-130	2.155	2.693
120	Undivided plate	OP3H-120	2.027	2.533
110	Undivided plate	OP3H-110	1.927	2.408



Edge profile 1

Harlekin



Edge profile 2

Arched



Edge profile 3

Pisa (rounded)



Edge profile 4

Straight

PRICELIST

Round dining table (extendable)



PRICE (EUR)				
OPTIC extendable round dining table H74 cm w/3 cm wooden plate				
D (cm)	Description	Item no.	ASH	OAK
140	Extension for 4 leaves*	OP3M-140	2.651	3.314
130	Extension for 4 leaves*	OP3M-130	2.513	3.141
120	Extension for 4 leaves*	OP3M-120	2.385	2.981
110**	Extension for 4 leaves*	OP3M-110**	2.285	2.856

* Comes with 2 support legs

** The extension system is 8 cm from the edge!

PRICE (EUR)				
OPTIC leaf for extendable round dining table, 3 cm plate thickness				
Size (cm)	Description	Item no.	ASH	OAK
50x140	Leaf 50x140 cm	OPT3-140	440	549
50x130	Leaf 50x130 cm	OPT3-130	415	519
50x120	Leaf 50x120 cm	OPT3-120	383	478
50x110	Leaf 50x110 cm	OPT3-110	358	447



Edge profile 1

Harlekin



Edge profile 2

Arched



Edge profile 3

Pisa (rounded)



Edge profile 4

Straight

PRICELIST

Round coffee table w/wooden top



PRICE (EUR)						
<i>OPTIC round coffee table w/2 cm wooden plate (item no.: OPCR2)</i>						
D (cm)	H 36 cm		H 42 cm		H 48 cm	
	ASH	OAK	ASH	OAK	ASH	OAK
100	858	1.073	901	1.126	946	1.182
88	715	894	751	938	788	985
76	572	715	602	753	632	790
60	532	665	560	700	588	735

Standard sizes

Height:

- H36, 42 or 48 cm

Floor to cross bar:

- H36 = 8, H42 = 10, H48 = 12 cm

Special sizes

Other height:

- Standard price +20%

Other size:

- Ask for price (max diameter 100)

PRICELIST

Round coffee table w/glass



PRICE (EUR)						
OPTIC round coffee table w/glass (item no.: OPCRG)						
D (cm)	H 36 cm		H 42 cm		H 48 cm	
	ASH	OAK	ASH	OAK	ASH	OAK
100	760	836	798	878	838	922
88	634	697	665	732	699	768
76	507	558	528	581	554	610
60	471	519	491	540	516	567

Standard sizes

Height:

- H36, 42 or 48 cm

Floor to cross bar:

- H36 = 8, H42 = 10, H48 = 12 cm

Special sizes

Other height:

- Standard price +20%

Other size:

- Only made in standard diameter!

PRICELIST

Square coffee table w/wooden "tray" (not removable)



PRICE (EUR)				
OPTIC coffee table w/wooden "tray" (item no.: OPCSW)				
L x B (cm)	H 42 cm		H 48 cm	
	ASH	OAK	ASH	OAK
77 x 77	795	993	834	1.043
67 x 67	676	844	709	887

Standard sizes

Height:
- H42 or 48 cm

Floor to cross bar:
- H42 = 16, H48 = 16 cm

Special sizes

Other height:
- Standard price +20%

Other size:
- Ask for price

PRICELIST

Square coffee table w/glass & storage room



PRICE (EUR)				
OPTIC square coffee table w/glass (item no.: OPCSG)				
L x W (cm)	H 42 cm		H 48 cm	
	ASH	OAK	ASH	OAK
77 x 77	1.191	1.310	1.215	1.336
67 x 67	1.012	1.113	1.032	1.136

Standard sizes

Height:
- H42 or 48 cm

Floor to cross bar:
- H42 = 16, H48 = 16 cm

Special sizes



Other height:
- Standard price +20%

Other size:
- Only made in standard width x length!

PRICELIST

Wall mount HIFI-sideboard

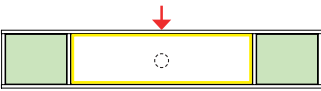
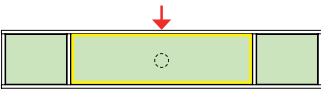
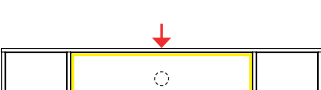

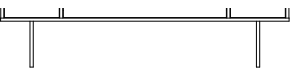
HIFI-SIDEBOARD (veneered)						
Description	Item no.	Size (cm)			Price (EUR)	
		B	D	H	ASH	OAK
 HIFI-sideboard (wallmount)	OPH1	176	30	32	1.146	1.156
 HIFI-sideboard (wallmount)	OPH2	176	30	32	1.190	1.200
 HIFI-sideboard (wallmount)	OPH3	176	30	32	1.236	1.256
 HIFI-sideboard (wallmount)	OPH4	176	30	32	1.146	1.156
 Wooden legs (for OPH1-OPH4)	OPHLW	176	30	28	133	150
 Steel legs (for OPH1-OPH4)	OPHLS	176	30	28	158	

 Flip door

 Front w/HIFI fabric

 Rear wall w/ hole for cables

 Hole for wires, centered at the top towards the wall



HIFI FABRIC

Green colour



WIRING WITHDRAWAL

Red arrow



WOOD LEG

OPHLW



STEEL LEG

OPHLS

PRICELIST

Wall mount shelves



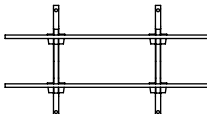
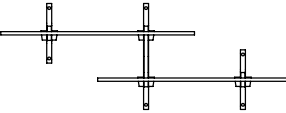
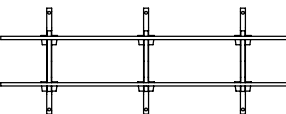
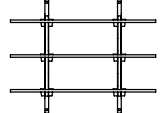
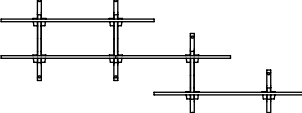



SET OF SHELVES (veneered)						
Description	Item no.	Size (cm)			Price (EUR)	
		B	D	H	ASH	OAK
	OPS1	117	26	36	233	245
	OPS2	117	26	64	402	425
	OPS3	175,5	26	64	417	440
	OPS4	175,5	26	64	543	578
	OPS5	117	26	92	574	604
	OPS6	234	26	92	677	715

Standard sizes only.

PRICELIST

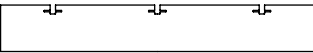
Parts for wall mount shelves

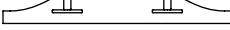
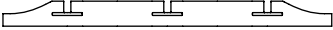

SHELF PARTS (veneered)						
Description	Item no.	Size (cm)			Price (EUR)	
		B	D	H	ASH	OAK
	OPSS	117	26	1,9	122	122
	OPSL	175,5	26	1,9	161	161
	OPS36	3	7	36	66	72
	OPS64	3	7	64	84	94
	OPS92	3	7	92	106	121
8X 	OPS8WED (Set of 8 wedges)				18	18
8X 	OPS8PLU (Set of 8 wooden plugs)				14	14

Standard sizes only.

WOOD COLOURS

Images for guiding purpose only!

The wood structure and colour will vary from ash and oak.

We therefore recommend using the wood samples/exhibition furniture to get a more accurate impression.



ASH C3 / OAK C3
Lacquered

We treated this wood with lacque.

C3 are only made for products without patination.



ASH C4 / OAK C4
Natural oiled

We treated this wood with our 'Natural oil'.



ASH C6 / OAK C6
White oiled

We treated this wood with our 'White oil'.



ASH C8 / OAK C8
Soaped

We treated this wood with soap.

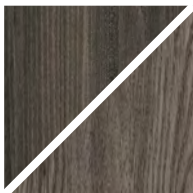

ASH C11 / OAK C11
Dark grey oiled

We treated this wood with our 'Black oil'.



ASH C12 / OAK C12
Antique brown oiled

We treated this wood with our 'Antique brown oil'.



ASH C13 / OAK C13
Light grey oiled

We treated this wood with our 'Light grey oil'.



ASH C14 / OAK C14
Black stained & oiled

We treated this wood with black stain, and treated it with a wax oil.

C14 is for legs and storage furniture only!



ASH C15 / OAK C15
Mocca brown oiled

We treated this wood with our 'Mocca brown oil'.

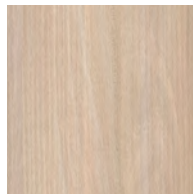

ASH C16
Warm white oiled

We treated this wood with our 'Warm white oil'.

C16 is only for ash



ASH C20 / OAK C20
Grey brown oiled

We treated this wood with our 'Grey brown oil'.



ASH C44 / OAK C44
Black matt lacquered

We treated this wood with black stain, and treated it with matt lacque.

C44 is only for plates and can only be made for products without patination.



For more information about maintenance, please visit our website:
WWW.KRISTENSEN.COM



We also offers our own repairoils for our products
- contact us if you need a pricelist.

PRICELIST

Lazy Susan – turntable (rotating tray)

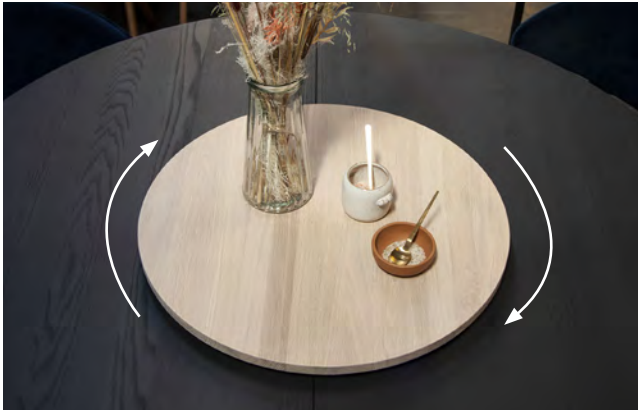

The plate has a turning function.
The product can be used with all our round dining tables.

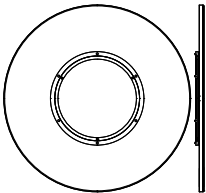
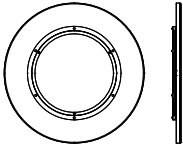
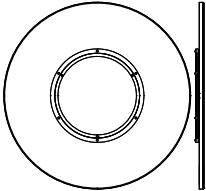
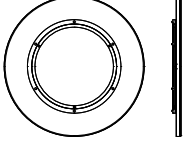

Price: LAZY SUSAN, plate thickness 2 cm				
Description	Item no.	Measure (cm)		Price (EUR)
		D	H	
 Lazy Susan turning plate in ASH	LAZY-80	80	4	503
 Lazy Susan turning plate in ASH	LAZY-60	60	4	441
 Lazy Susan turning plate in OAK	LAZY-80	80	4	679
 Lazy Susan turning plate in OAK	LAZY-60	60	4	571

Edge profile for
LAZY SUSAN



4
Straight edge

MEASURES

*Space for the chair opposite the table leg
- in all the different table sizes*



OPTIC DINING TABLE

Ø110	X = 37 cm
Ø120	X = 32 cm
Ø130	X = 27 cm
Ø140	X = 22 cm

*Estimated number of chairs fitting around
the table - when the chair is 50 cm wide*

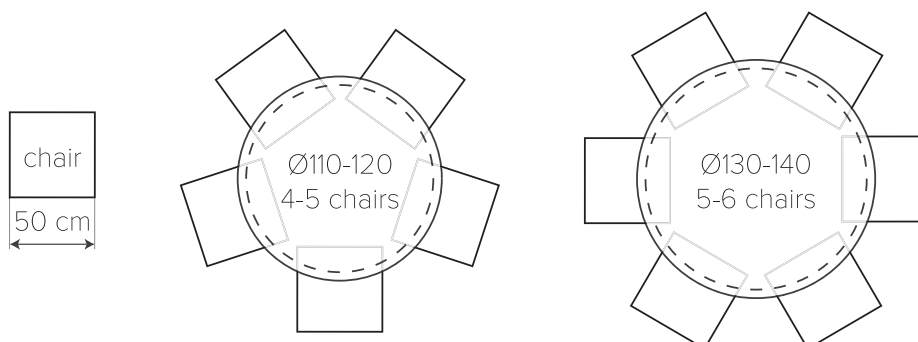

OTA YHTEYTTÄ

MITTATILAUSPÖYDÄT

Voimme tehdä kaikkia pöytämallejimme mittojen mukaan. Mittatilaustuotteet vaativat erikoiskäsittelyä: materiaalin käsittelyä, uusia piirroksia, työstökoneiden asetusten kohdentamista sekä tuotteiden paketoitua. Tästä johtuen mittatilaustuotteisiin lisätään aina erikoistyölisä, oli tuote suurempi tai pienempi kuin standardikoko. Jos esimerkiksi haluat pöydän pienempänä, lisätään lähimpää kokoa olevan tuotteen hintaan erikoistyölisä +15%.

Olen meihin yhteydessä lisätietoja saadaksesi!

Head office, Denmark

OSOITE:

Kristensen & Kristensen A/S
Storstrømsvej 44
6715 Esbjerg N
DK - Denmark

PUHELIN:

+45 75470303

FAX:

+45 75470304

KOTISIVU:

www.kristensen.com

MAIL:

kristensen@kristensen.dk

TILAUKSET:

order@kristensen.dk

REKLAMAATIOT:

claim@kristensen.dk

Edustaja Suomessa

Jokko Salmevaara

—

✉ jokko.salmevaara@boknas.fi

☎ +358 040 195 8886