

Range
—
ZET



PRICELIST

OVH-HINNASTO (sis. alv. 25,5%) - EURO

FINLAND

01.01.2024



Range

ZET

ZET is a light and elegant range, designed in collaboration with norwegian RIIS Interiør from Oslo. The furniture is as standard made of ash wood, with a tight and cubic steel frame.

Designed by

Else Marie Risøe Evensen
(*RIIS Interiør*)



This range include

Dining tables | Coffee tables
Sideboards | HIFI sideboards
Cabinets | Benches
Shelf furniture | Desks
Console tables | Nightstands
Sidetables

Features



Design elements

Choose between different designs on plates and legs.



Custommade

In addition to our many standard sizes we can accommodate special requests.



Wood colours

Choose between more than 10+ different wood colours in both ash and oak.



Sustainable choice

Solid wood furniture can last a lifetime with proper maintenance

Social media

Follow and share with us on Instagram.

 @kristensenfurniture | #kristensenfurniture

Pricelist- and imagebank

On our Collection-site you as a retailer always have access to the latest pricelists and hundreds of high resolution images and videos - **Free to use in your marketing!**

If you do not have a password yet, please contact the Kristensen sales office in Denmark.

LINK:

collection.kristensen.com

PRICELIST

Round dining table w/ or w/o middle extension and angled legs



Additional information

Special orders larger than standard may be too unstable.

- Max diameter is 160 cm, sizes above become too unstable.

Plate thickness: 3 cm.

Steel profile: 3x3 cm.

Item no. 641V

Round dining table w/angled legs (plate thickness 3 cm)				
Size (cm)	Price (EUR)			
	Without middle extension		With middle extension	
	Ash	Oak	Ash	Oak
D160 H74 cm	3.003	3.848	3.457	4.429
D150 H74 cm	2.601	3.332	3.006	3.851
D140 H74 cm	2.067	2.648	2.430	3.113
D130 H74 cm	1.850	2.371	2.116	2.711
D120 H74 cm	1.620	2.075	1.836	2.353
D110 H74 cm	1.466	1.879	1.669	2.138
D100 H74 cm	1.327	1.700	1.515	1.941

 **1-4 leaves**
2 support legs are provided for tables in the size of 150-160 cm.

 **1 leaf**

* Comes with 2 support legs

Leaf for tables with middle extension				
Size (cm)	Price (EUR)			
	Item no. 631 Plate in quality as the table		Item no. 631P Plate made from small pieces	
	Ash	Oak	Ash	Oak
45x160 H3 cm	469	601	433	554
45x150 H3 cm	446	571	411	527
45x140 H3 cm	415	532	383	491
45x130 H3 cm	396	508	365	468
45x120 H3 cm	388	497	358	459
45x110 H3 cm	381	488	351	450
45x100 H3 cm	373	478	344	441



LEAF SMALL PIECES
Item no. 631P

Plate made of small stick-glued planks

Stainless steel = + 10%

All prices are retail prices (including VAT 25,5%) in Euro.
We accept no liability for any errors or omissions.

PRICELIST

Round dining table w/ or w/o middle extension and straight legs



Additional information

Special orders larger than standard may be too unstable.

- Max diameter is 160 cm, sizes above become too unstable.

Plate thickness: 3 cm.

Steel profile: 3x3 cm.

Item no. 641

Round dining table w/straight legs (plate thickness 3 cm)				
Size (cm)	Price (EUR)			
	Without middle extension		With middle extension	
	Ash	Oak	Ash	Oak
D160 H74 cm	2.478	3.175	2.921	3.743
D150 H74 cm	2.142	2.745	2.539	3.254
D140 H74 cm	2.118	2.714	2.491	3.191
D130 H74 cm	1.897	2.430	2.169	2.778
D120 H74 cm	1.660	2.127	1.882	2.412
D110 H74 cm	1.503	1.926	1.710	2.192
D100 H74 cm	1.360	1.742	1.553	1.990

 **1-4 leaves**
2 support legs are provided for tables in the size of 150-160 cm.

 **1 leaf**

* Comes with 2 support legs

Leaf for tables with middle extension				
Size (cm)	Price (EUR)			
	Item no. 631 Plate in quality as the table		Item no. 631P Plate made from small pieces	
	Ash	Oak	Ash	Oak
45x160 H3 cm	469	601	433	555
45x150 H3 cm	448	573	413	529
45x140 H3 cm	426	545	393	503
45x130 H3 cm	406	520	375	480
45x120 H3 cm	398	510	367	470
45x110 H3 cm	390	500	360	461
45x100 H3 cm	382	490	352	452



LEAF SMALL PIECES
Item no. 631P

Plate made of small stick-glued planks

Stainless steel = + 10%

All prices are retail prices (including VAT 25,5%) in Euro.
We accept no liability for any errors or omissions.

PRICELIST

Rectangular coffee table



Item no. H45: 6341

Item no. H52: 6342

Coffee table Price (EUR)						
Ash H45 or H52 cm						
L 140	964	1.123	1.282	1.459	1.624	1.779
130	928	1.080	1.245	1.422	1.575	1.727
120	888	1.035	1.218	1.370	1.492	1.648
110	876	1.022	1.181	1.321	1.459	1.633
100	864	1.004	1.147	1.300	1.428	1.459
90	851	989	1.129	1.276	1.300	1.321
80	845	983	1.117	1.129	1.147	1.181
	60	70	80	90	100	110

Coffee table Price (EUR)						
Oak H45 or H52 cm						
L 140	1.236	1.439	1.642	1.869	2.080	2.280
130	1.189	1.384	1.595	1.822	2.018	2.213
120	1.138	1.325	1.560	1.756	1.912	2.111
110	1.122	1.310	1.513	1.693	1.869	2.092
100	1.107	1.286	1.470	1.666	1.830	1.869
90	1.091	1.267	1.447	1.634	1.666	1.693
80	1.083	1.259	1.431	1.447	1.470	1.513
	60	70	80	90	100	110

Additional information

Plate thickness: 2 cm.

Steel profile: 2x2 cm.

Alternative size = surcharge.

Stainless steel = + 10%

All prices are retail prices (including VAT 25,5%) in Euro.
We accept no liability for any errors or omissions.

PRICELIST

Round coffee table



Item no. H52: 6392

Item no. H45: 6391

Round coffee table Price (EUR)

Ash

H 52	520	559	597	647	705	743	800	870	901
45	508	546	584	635	692	730	787	857	889
	D 36	42	48	54	60	66	72	78	84

Round coffee table Price (EUR)

Oak

H 52	667	716	764	830	903	952	1.025	1.114	1.155
45	651	699	748	813	886	935	1.008	1.098	1.139
	D 36	42	48	54	60	66	72	78	84

Additional information

Special orders larger than standard may be too unstable.

Plate thickness: 2 cm.

Steel profile: 2x2 cm.

Alternative size = surcharge.

Round coffee tables are delivered assembled.

Stainless steel = + 10%

All prices are retail prices (including VAT 25,5%) in Euro.
We accept no liability for any errors or omissions.

PRICELIST

Console table w/ or w/o shelf

—



Item no. 636

Console table Price (EUR)						
Dimensions (cm)			Ash		Oak	
W	D	H	w/"V"	w/shelf	w/"V"	w/shelf
100	30	80	838	933	1.074	1.196
110	30	80	851	952	1.090	1.220
120	30	80	870	971	1.114	1.244
130	30	80	901	1.003	1.155	1.285
150	30	80	971	1.124	1.244	1.440
200	30	80	1.066	1.231	1.366	1.578

Additional information

—

Console tables are delivered assembled.

Stainless steel = + 10%

All prices are retail prices (including VAT 25,5%) in Euro.

We accept no liability for any errors or omissions.

PRICELIST

Bench



Item no. 633

Bench w/"V"				
Dimensions (cm)			Price (EUR)	
W	D	H	Ash	Oak
160	35	45	952	1.220
180	35	45	965	1.236
200	35	45	978	1.252
220	35	45	997	1.277
240	35	45	1.035	1.326

Additional information

Plate thickness: 2 cm.

Steel profile: 2x2 cm.

Alternative size = surcharge.

Stainless steel = + 10%

All prices are retail prices (including VAT 25,5%) in Euro.
We accept no liability for any errors or omissions.

PRICELIST

Shelf furniture



Item no. 634

Shelf unit				
Dimensions (cm)			Price (EUR)	
W	D	H	Ash	Oak
140	40	80	1.379	1.767

Additional information

The shelf furniture are delivered assembled.

Stainless steel = + 10%

All prices are retail prices (including VAT 25,5%) in Euro.
We accept no liability for any errors or omissions.

PRICELIST

Desk w/2 "push" drawers



Item no. H75 635

Item no. H90 637

Desk w/2 drawers				
Dimensions (cm)			Price (EUR)	
W	D	H	Ash	Oak
100	40	75	1.370	1.756
110	40	75	1.416	1.814
120	40	75	1.465	1.877
130	40	75	1.504	1.928
150	40	75	1.587	2.033

Night stand w/ 1 "push" drawer



Item no. 627

Night stand w/1 drawer				
Dimensions (cm)			Price (EUR)	
W	D	H	Ash	Oak
50	40	60	928	1.189

Additional information

The shelf furniture are delivered assembled.

Stainless steel = + 10%

All prices are retail prices (including VAT 25,5%) in Euro.
We accept no liability for any errors or omissions.

PRICELIST

HIFI sideboard with textile and "push" doors/drawers

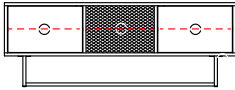
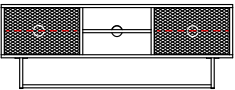
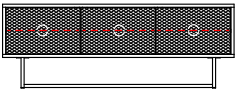
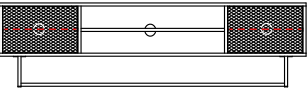
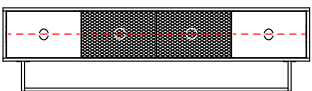

HIFI-sideboard with HIFI-fabric					
Description + drawing	Dimensions (cm)			Price (EUR)	
	W	D	H	Ash	Oak
item no. 6362 2 doors (veneer), 1 door (w/textile), 3 cable holes in the back 	151	40	55	1.918	2.458
item no. 6363 2 doors (w/textile), 1 open space, 3 cable holes in the back 	151	40	55	1.743	2.233
item no. 6364 3 doors (w/textile), 3 cable holes in the back 	151	40	55	1.821	2.333
item no. 6367 2 doors (w/textile), 1 open space, 3 cable holes in the back 	200	40	55	2.032	2.604
item no. 6366 2 doors (veneer), 2 doors (w/textile), 4 cable holes in the back 	200	40	55	2.080	2.665

--- Wood shelf inside



Please note that we can not guarantee that the HIFI fabric works with all infrared devices.

Overview of which doors are left and right hinged on all ZET cabinets

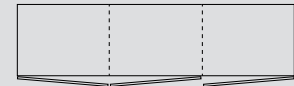

3 sections

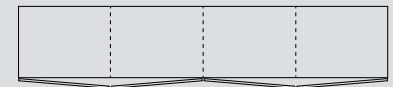

4 sections

Additional information

Plate thickness: 2 cm.

Steel profile: 2x2 cm.

Removable wooden shelves

- max. 20 kg - evenly distributed.

Adjustable shelves

The shelves can be adjusted a little bit up/down from the standard position.

Stainless steel = + 10%

All prices are retail prices (including VAT 25,5%) in Euro.
We accept no liability for any errors or omissions.

PRICELIST

Wallmounted HIFI sideboard with textile and "push" doors/drawers

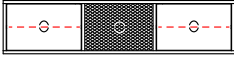
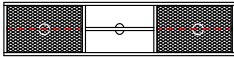
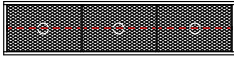
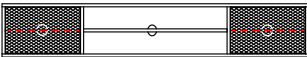
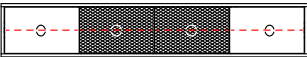

HIFI-sidebaord with fabric - wall mount					
Description + drawing	Dimensions (cm)			Price (EUR)	
	W	D	H	Ash	Oak
item no. 6362W 2 doors (veneer) 1 door (w/textile) 3 cable holes in the back 	151	42	35	1.918	2.458
item no. 6363W 2 doors (w/textile), 1 open space 3 cable holes in the back 	151	42	35	1.743	2.233
item no. 6364W 3 doors (w/textile) 3 cable holes in the back 	151	42	35	1.821	2.333
item no. 6367W 2 doors (w/textile), 1 open space 3 cable holes in the back 	200	42	35	2.032	2.604
item no. 6366W 2 doors (veneer) 2 doors (w/textile) 4 cable holes in the back 	200	42	35	2.080	2.665

--- Wood shelf inside



Please note that we can not guarantee that the HIFI fabric works with all infrared devices.

Overview of which doors are left and right hinged on all ZET cabinets

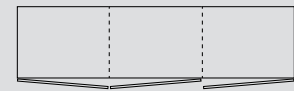

3 sections

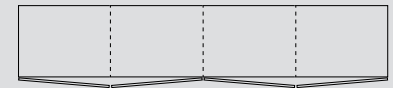

4 sections

Additional information

Plate thickness: 2 cm.

Steel profile: 2x2 cm.

Removable wooden shelves

- max. 20 kg - evenly distributed.

Adjustable shelves

The shelves can be adjusted a little bit up/down from the standard position.

Stainless steel = + 10%



All prices are retail prices (including VAT 25,5%) in Euro.

We accept no liability for any errors or omissions.

PRICELIST

HIFI sideboard "push" doors/drawer

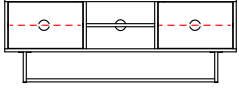

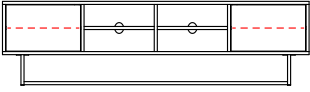
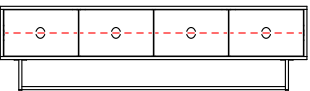
HIFI-sideboard					
Description + drawing	Dimensions (cm)			Price (EUR)	
	W	D	H	Ash	Oak
item no. 6373 2 doors (veneer) 1 open space 3 cable holes in the back 	151	40	55	1.743	2.233
item no. 6374 3 doors (veneer) 3 cable holes in the back 	151	40	55	1.919	2.459
item no. 6375 2 doors (veneer) 2 open spaces 4 cable holes in the back 	200	40	55	2.032	2.604
item no. 6376 4 doors (veneer) 4 cable holes in the back 	200	40	55	2.081	2.666

--- Wood shelf inside

Overview of which doors are left and right hinged on all ZET cabinets

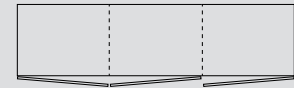

3 sections

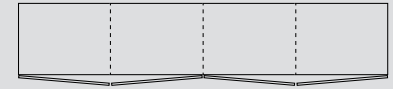

4 sections

Additional information

Plate thickness: 2 cm.

Steel profile: 2x2 cm.

Removable wooden shelves

- max. 20 kg - evenly distributed.

Adjustable shelves

The shelves can be adjusted a little bit up/down from the standard position.





Stainless steel = + 10%

All prices are retail prices (including VAT 25,5%) in Euro.
We accept no liability for any errors or omissions.

PRICELIST

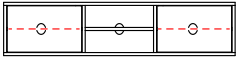
Wallmounted HIFI sideboard "push" doors/drawer



HIFI-sideboard - wall mount					
Description + drawing	Dimensions (cm)			Price (EUR)	
	W	D	H	Ash	Oak
item no. 6373W 2 doors (veneer) 1 open space 3 cable holes in the back 	151	42	35	1.786	2.346
item no. 6374W 3 doors (veneer) 3 cable holes in the back 	151	42	35	1.967	2.584
item no. 6375W 2 doors (veneer) 2 open spaces 4 cable holes in the back 	200	42	35	2.083	2.735
item no. 6376W 4 doors (veneer) 4 cable holes in the back 	200	42	35	2.133	2.801

--- Wood shelf inside

Overview of which doors are left and right hinged on all ZET cabinets

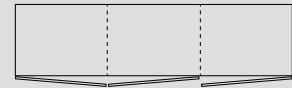

3 sections

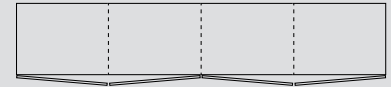

4 sections

Additional information

Plate thickness: 2 cm.

Steel profile: 2x2 cm.

Removable wooden shelves

- max. 20 kg - evenly distributed.

Adjustable shelves

The shelves can be adjusted a little bit up/down from the standard position.





Stainless steel = + 10%

All prices are retail prices (including VAT 25,5%) in Euro.
We accept no liability for any errors or omissions.

PRICELIST

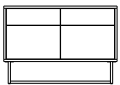
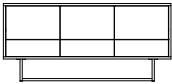
Sideboards w/push drawers + doors. Height 70 cm

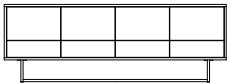

Sideboard H70 cm					
Description + drawing	Dimensions (cm)			Price (EUR)	
	W	D	H	Ash	Oak
item no. 6337 - 2 doors 	102	40	70	1.673	2.197
item no. 6338 - 2 doors, 2 drawers 	102	40	70	1.999	2.625
item no. 6343 - 3 doors, 3 drawers 	151	40	70	2.556	3.356
item no. 6344 - 3 doors 	151	40	70	1.952	2.563
item no. 6345 - 4 doors, 4 drawers 	200	40	70	3.105	4.077
item no. 6346 - 4 doors 	200	40	70	2.419	3.177

--- Wood shelf inside

Overview of which doors are left and right hinged on all ZET cabinets

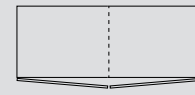

2 sections

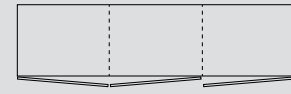

3 sections

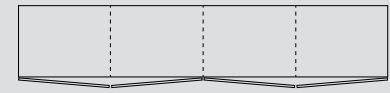

4 sections

Additional information

Plate thickness: 2 cm.

Steel profile: 2x2 cm.

Removable wooden shelves
- max. 20 kg - evenly distributed.

Adjustable shelves

The shelves can be adjusted a little bit up/down from the standard position.

Stainless steel = + 10%

All prices are retail prices (including VAT 25,5%) in Euro.
We accept no liability for any errors or omissions.

PRICELIST

Sideboards w/push drawers + doors. Height 85 cm

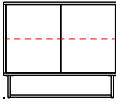
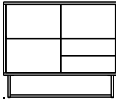
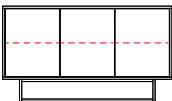
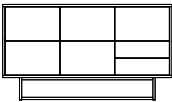
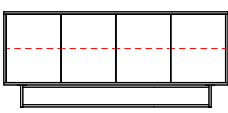
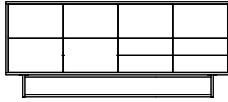

Sideboard H85 cm					
Description + drawing	Dimensions (cm)			Price (EUR)	
	W	D	H	Ash	Oak
item no. 6301 - 2 doors 	102	40	85	1.923	2.525
item no. 6302 - 2 doors, 2 drawers 	102	40	85	2.427	3.187
item no. 6303 - 3 doors 	151	40	85	2.243	2.946
item no. 6304 - 5 doors, 2 drawers 	151	40	85	2.808	3.687
item no. 6305 - 4 doors 	200	40	85	2.784	3.656
item no. 6306 - 6 doors, 4 drawers 	200	40	85	3.409	4.477

--- Wood shelf inside

Overview of which doors are left and right hinged on all ZET cabinets

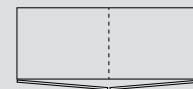

2 sections

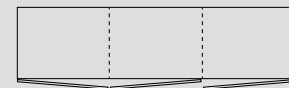

3 sections

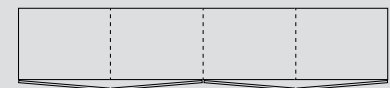

4 sections

Additional information

Plate thickness: 2 cm.

Steel profile: 2x2 cm.

Removable wooden shelves
- max. 20 kg - evenly distributed.

Adjustable shelves

The shelves can be adjusted a little bit up/down from the standard position.

Stainless steel = + 10%

All prices are retail prices (including VAT 25,5%) in Euro.
We accept no liability for any errors or omissions.

PRICELIST

Glass cabinet w/handles on the glass doors.



BI
Handle in black steel



MI
Handle in brass

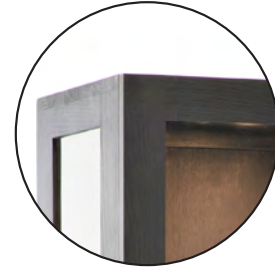

The glass doors are mounted on the outer side of the corpus.
Only on item no. 6347 + 6348!

Overview of which doors are left and right hinged on all ZET cabinets

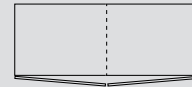

2 sections

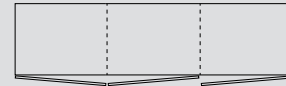

3 sections

Additional information

Plate thickness: 2 cm.

Steel profile: 2x2 cm.

Removable glass shelves.

- max. 12 kg - evenly distributed.

LED light in top of the cabinet.

Adjustable shelves.

The shelves can be adjusted a little bit up/down from the standard position.

Soft close

The glass doors with handles are with soft close.

● *Handles - See options on page. 31*

--- *Wood shelf inside*

We use tempered glass on our vitrines

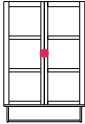
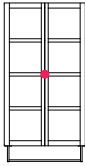
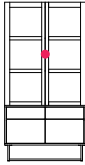
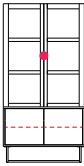
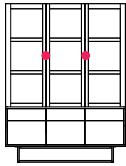
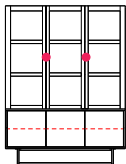
Vitrine						
Description + drawing	Dimensions (cm)			Price (EUR)		
	W	D	H	Ash	Oak	
item no. 63570 - 2 doors 	102	40	157	2.429	3.112	
item no. 63470 - 2 doors 	102	40	200	2.855	3.657	
item no. 663480 - 4 doors, 2 drawers 	102	40	200	4.369	5.598	
item no. 63530 - 4 doors 	102	40	200	3.213	4.117	
item no. 63540 - 6 doors, 3 drawers 	151	40	200	5.153	6.603	
item no. 63520 - 6 doors 	151	40	200	4.736	6.067	

Stainless steel = + 10%

All prices are retail prices (including VAT 25,5%) in Euro.

We accept no liability for any errors or omissions.

WOOD COLOURS



Images for guiding purpose only!

The wood structure and colour will vary from ash and oak.

We therefore recommend using the wood samples/exhibition furniture to get a more accurate impression.



ASH C3 / OAK C3
Lacquered

We treated this wood with lacque.

C3 are only made for products without patination.



ASH C4 / OAK C4
Natural oiled

We treated this wood with our 'Natural oil'.



ASH C6 / OAK C6
White oiled

We treated this wood with our 'White oil'.



ASH C8 / OAK C8
Soaped

We treated this wood with soap.

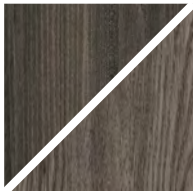

ASH C11 / OAK C11
Dark grey oiled

We treated this wood with our 'Black oil'.



ASH C12 / OAK C12
Antique brown oiled

We treated this wood with our 'Antique brown oil'.



ASH C13 / OAK C13
Light grey oiled

We treated this wood with our 'Light grey oil'.



ASH C14 / OAK C14
Black stained & oiled

We treated this wood with black stain, and treated it with a wax oil.

C14 is for legs and storage furniture only!



ASH C15 / OAK C15
Mocca brown oiled

We treated this wood with our 'Mocca brown oil'.

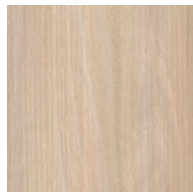

ASH C16
Warm white oiled

We treated this wood with our 'Warm white oil'.

C16 is only for ash



ASH C20 / OAK C20
Grey brown oiled

We treated this wood with our 'Grey brown oil'.



ASH C44 / OAK C44
Black matt lacquered

We treated this wood with black stain, and treated it with matt lacque.

C44 is only for plates and can only be made for products without patination.



For more information about maintenance, please visit our website:
WWW.KRISTENSEN.COM



We also offers our own repairoils for our products
- contact us if you need a pricelist.

Stainless steel = + 10%

All prices are retail prices (including VAT 25,5%) in Euro.
We accept no liability for any errors or omissions.

WOOD FINISH



UP

Without patination

The wood is planned and sanded to achieve a smooth surface.

With few and smaller knots.

Storage furniture can only be made with this finish!



SC

Soft Cracks

Naturally occurring cracks are made more visible which gives a rustic look with cracks in the surface.

May contain more and larger knots.

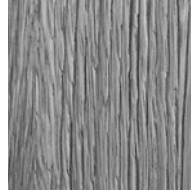

RL

Raw Look

We brush off the layer of softer wood which gives a look of wood that has been roughened by natural wear.

May contain more and larger knots.



FK

Filled Knots

The knots are filled and the wood is planned and sanded to achieve a smooth surface.

Only for OAK!

STEEL COLOUR & FINISH

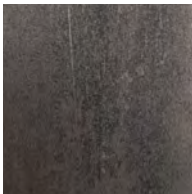

A

Industrial steel

Industrial steel has a raw and matte appearance with shades of colors emerged during casting.

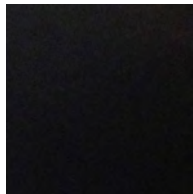

B

Black painted steel

Black painted steel has a graphical and simple look, that fits nicely in most homes.

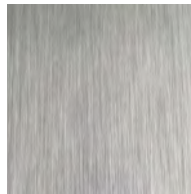

C

Brushed stainless steel

Brushed, stainless steel has an elegant appearance with a uniform finish created by hand.

Extra cost!

HANDLES



BI

I-handles in blackpainted steel



MI

I-handles in brass

Stainless steel = + 10%

All prices are retail prices (including VAT 25,5%) in Euro.
We accept no liability for any errors or omissions.

MEASURES

Measures for estimating the number of chairs fitting around these tables

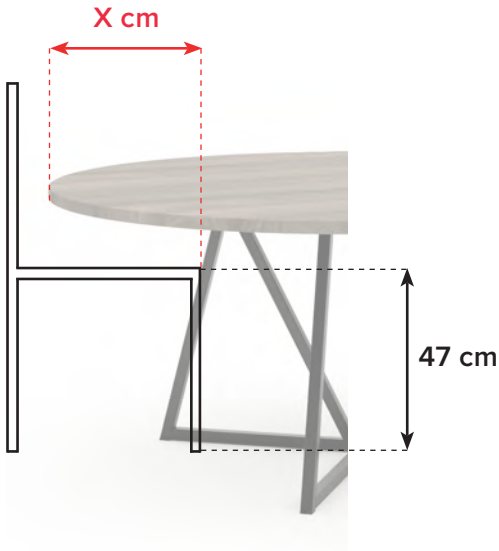

ITEM NO. 641V

Ø100	X = 26,5 cm
Ø110	X = 31,5 cm
Ø120	X = 31,5 cm
Ø130	X = 31,5 cm
Ø140	X = 31,5 cm
Ø150	X = 31,5 cm
Ø160	X = 31,5 cm

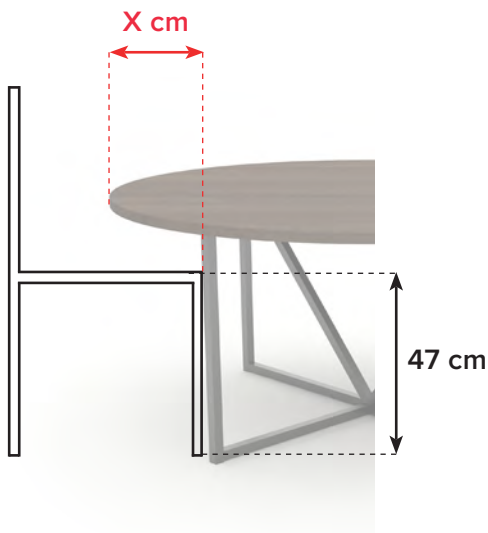

ITEM NO. 641

Ø100	X = 14 cm
Ø110	X = 14 cm
Ø120	X = 14 cm
Ø130	X = 14 cm
Ø140	X = 14 cm
Ø150	X = 14 cm
Ø160	X = 14 cm

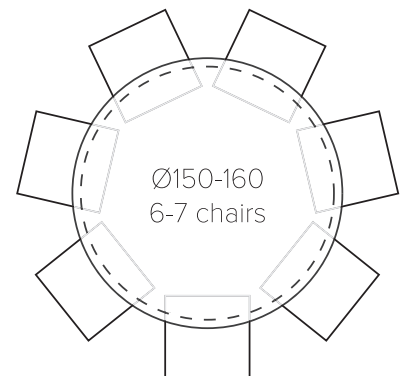
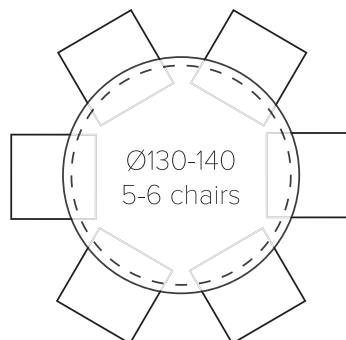
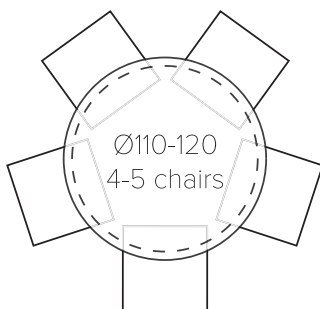
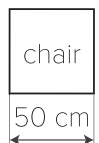

Stainless steel = + 10%

All prices are retail prices (including VAT 25,5%) in Euro.
We accept no liability for any errors or omissions.

OTA YHTEYTTÄ

MITTATILAUSPÖYDÄT

Voimme tehdä kaikkia pöytämallejimme mittojen mukaan. Mittatilaustuotteet vaativat erikoiskäsittelyä: materiaalin käsittelyä, uusia piirroksia, työstökoneiden asetusten kohdentamista sekä tuotteiden paketoitua. Tästä johtuen mittatilaustuotteisiin lisätään aina erikoistyölisä, oli tuote suurempi tai pienempi kuin standardikoko. Jos esimerkiksi haluat pöydän pienempänä, lisätään lähimpää kokoa olevan tuotteen hintaan erikoistyölisä +15%.

Olen meihin yhteydessä lisätietoja saadaksesi!

Head office, Denmark

OSOITE:

Kristensen & Kristensen A/S
Storstrømsvej 44
6715 Esbjerg N
DK - Denmark

PUHELIN:

+45 75470303

FAX:

+45 75470304

KOTISIVU:

www.kristensen.com

MAIL:

kristensen@kristensen.dk

TILAUKSET:

order@kristensen.dk

REKLAMAATIOT:

claim@kristensen.dk

Edustaja Suomessa

Jokko Salmevaara

—

✉ jokko.salmevaara@boknas.fi

☎ +358 040 195 8886